

European Organisation for Technical Approvals
Europäische Organisation für Technische Zulassungen
Organisation Européenne pour l'Agrément Technique

Established pursuant to Annex II of the Council Directive 89/106 of 21 December 1988 on the approximation of laws, regulations and administrative provisions of Member States relating to construction products (Construction Products Directive)

ETAG 029

GUIDELINE FOR
EUROPEAN TECHNICAL APPROVAL
of

METAL INJECTION ANCHORS FOR USE IN MASONRY

Edition April 2013

This Guideline for European Technical Approval is established and published in accordance with Article 11 of the Construction Products Directive as a basis for the preparation and issue of European Technical Approvals (ETA) in accordance with Article 9.1 of the Construction Products Directive.

European Technical Approvals are issued by Approval Bodies authorised and notified in accordance with Article 10 of the Construction Products Directive. These bodies are organized in EOTA.

The European Technical Approval, according to the Construction Products Directive, is a favourable technical assessment of the fitness for use of a construction product and the technical specification of the assessed product, serving as basis for the CE marking of this product when and where a harmonised standard according to the Directive is not or not yet available.

Due to technical innovation and the progress of the state of the art, Guidelines for technical approval might not reflect the latest developments and experiences gained in approval procedures. The reader of this Guideline is therefore advised to check with an EOTA member whether there are further provisions which have to be taken into account in the use of the Guideline.

Copyright © 2013 EOTA

Note: The copyright refers to the English reference version established by EOTA. For publications in accordance with Article 11.3 of the Construction Products Directive the national laws, regulations and administrative provisions of the Member State concerned are applicable.

This edition replaces edition June 2010 of ETAG 029

Table of contents

1	SCOPE OF THE ETAG	3
1.1	Definition of the construction product	3
1.2	Intended use of the construction product	6
1.3	Assumed working life of the construction product	6
1.4	Terminology	7
	1.4.1 Common terms relating to the Construction Products Directive	7
	1.4.2 Specific terms used in this ETAG	7
1.5	Procedure in the case of a significant deviation from the ETAG	8
2	ASSESSMENT OF FITNESS FOR USE	9
2.1	Meaning of "fitness for use"	9
2.2	Elements of the assessment of fitness for use	9
2.3	Relationship of requirements to the product characteristics and methods of verification and assessment	9
	2.3.1 Relationship of requirements to the product characteristics	9
	2.3.2 Use categories	11
2.4	Product characteristics which are relevant for the fitness for use relating to Mechanical Resistance and Stability (ER 1)	11
	2.4.1 Method of verification (General)	11
	2.4.2 Method of assessing and judging (general)	17
2.5	Verification methods relating to Safety in Case of Fire (ER 2)	25
2.6	Verification methods relating to Hygiene, Health and the Environment (ER 3)	26
2.7	Verification methods relating to Durability	27
3	EVALUATION AND ATTESTATION OF CONFORMITY AND CE MARKING	29
3.1	System of attestation of conformity	29
3.2	Tasks and responsibilities of the manufacturer and notified body	29
	3.2.1 Tasks of the manufacturer	29
	3.2.2 Tasks for the notified body	30
3.3	CE marking and accompanying information	31
3.4	Marking of the product	31
4	ASSUMPTIONS UNDER WHICH THE FITNESS FOR THE INTENDED USE IS ASSESSED	32
4.1	Design method for anchorages	32
4.2	Packaging, transport, storage of the product	32
4.3	Installation of the product in the works	32
5	IDENTIFICATION OF THE CONSTRUCTION PRODUCT	33
6	FORMAT OF ETAS ISSUED ON THE BASIS OF THE ETAG	35
6.1	Definition of the anchor and its intended use	35
6.2	Characteristics of the anchor with regard to safety in use and methods of verification	35
6.3	Evaluation and attestation of conformity and CE marking	36
6.4	Assumptions under which the fitness of the product for the intended use was favourably assessed	36
7	REFERENCE DOCUMENTS	36
Annex A	Details of Tests	
Annex B	Recommendations for tests to be carried out on construction works	
Annex C	Design methods for anchorages	

1 SCOPE OF THE ETAG

The ETAG "METAL INJECTION ANCHORS FOR USE IN MASONRY" covers the assessment of post-installed injection anchors placed into pre-drilled holes in masonry and anchored by bonding and mechanical interlock.

The injection anchors are intended to be used for anchorages for which requirements for mechanical resistance and stability and safety in use in the sense of the Essential Requirements N° 1 (ER 1) and N° 4 (ER 4) and, where applicable N° 2 (ER 2) and N° 3 (ER 3), of the CPD [1] shall be fulfilled; failure of anchorages made with these products would cause an immediate risk to human life and/or possibly lead to considerable economic consequences. They are for fixing and/or supporting structural elements (which contribute to the stability of the works) or heavy units.

The fixture can be supported either statically determinate (one or two supports) or statically indeterminate (more than two supports).

The following annexes are full parts of the ETAG:

- Annex A: Details of tests
- Annex B: Recommendations for tests to be carried out on construction works (informative)
- Annex C: Design methods for anchorages

1.1 Definition of the construction product

1.1.1 Types and operating principles

This ETAG applies to injection anchors consisting of a threaded rod, deformed reinforced bar, internal threaded socket, or other shapes and the mortar, placed into drilled holes in masonry and anchored by bonding the metal part to the sides of the drilled hole by means of mortar and by mechanical interlock (see Figure 1.1). For proper injection of the mortar, mesh sleeves made of metal or plastic are also covered in this ETAG (see Figure 1.2).

Injection anchors are supplied and used as a unit. However, if the metal parts are commercial standard parts supplied by another party than the approval holder (e.g. manufacturer of standard rods), specific conditions according to 4.3 have to be fulfilled.

1.1.2 Materials

This ETAG applies to anchors in which all the metal parts directly anchored in the masonry and designed to transmit the applied loads are made either of carbon steel, stainless steel or malleable cast iron.

The bonding material may be manufactured from cementitious mortar, synthetic mortar or a mixture of the two including fillers and/or additives.

1.1.3 Dimensions

This ETAG applies to anchors with a minimum thread size of 6 mm (M6).

The minimum anchorage depth of the anchor h_{ef} shall be 50 mm.

The maximum anchorage depth shall be $h_{ef} = h_{min} - 30$ mm.

This ETAG applies to applications where the minimum thickness of the masonry members in which injection anchors are installed is at least $h_{min} = 80$ mm.

Anchors with internal thread are covered only if they have a thread length of at least $d + 5$ mm after taking account of possible tolerances.

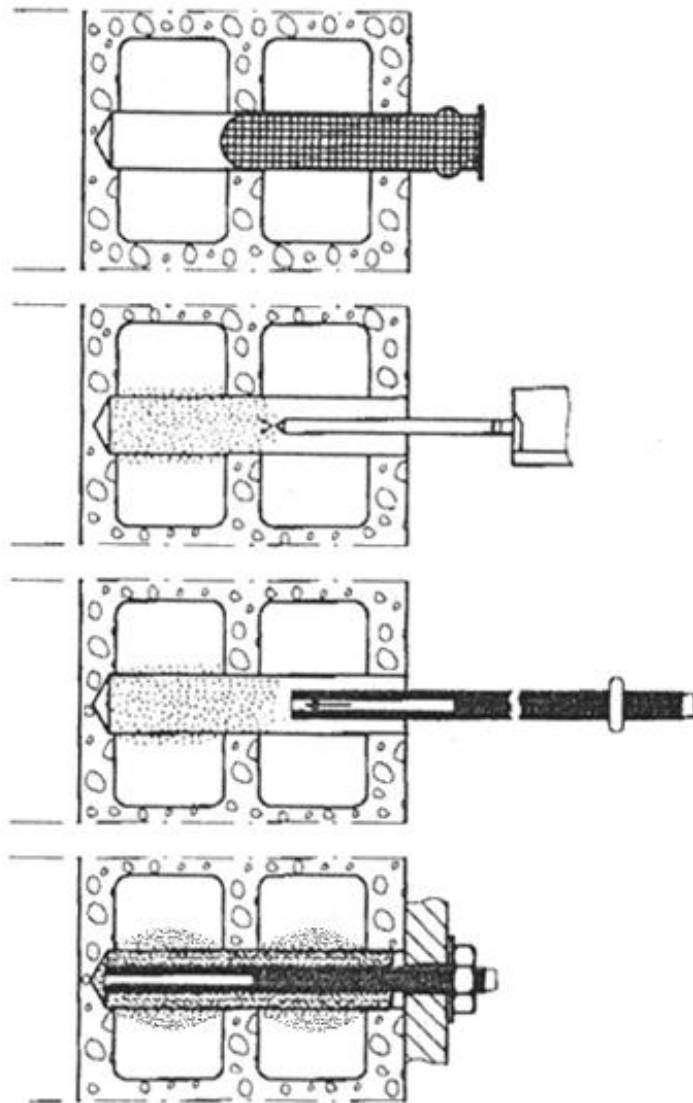
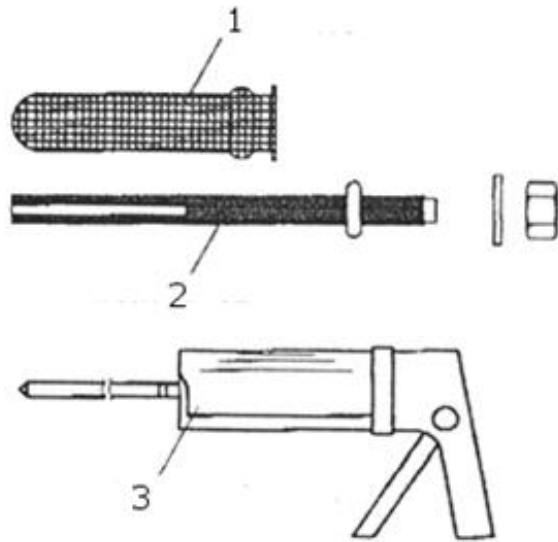
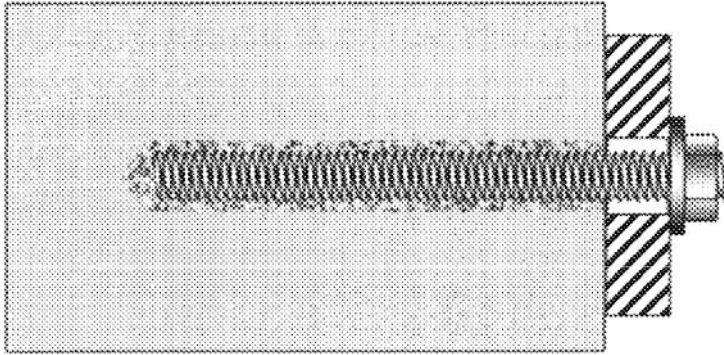
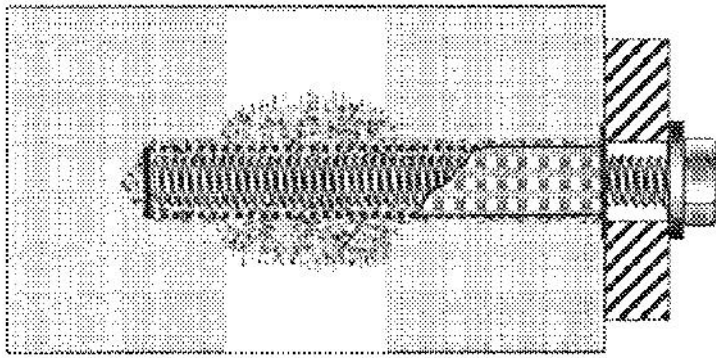

Figure 1.1 – Example of injection anchors



Threaded anchor rod set in solid brick using injection mortar



Threaded anchor rod set in perforated brick using injection mortar and mesh sleeve

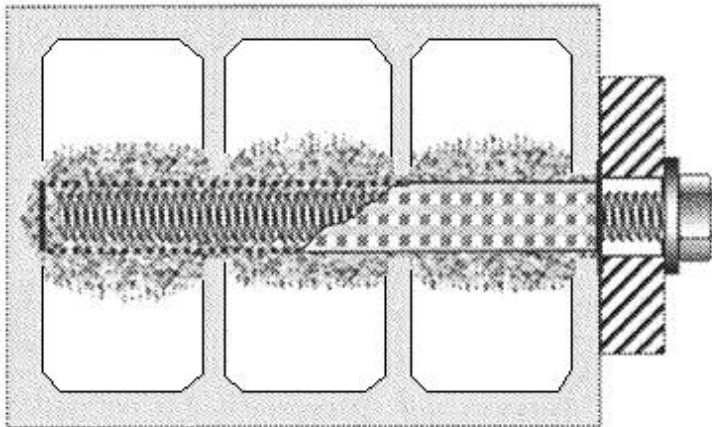

Threaded anchor rod set in hollow block using injection mortar and mesh sleeve

Figure 1.2 – Example of injection anchors

1.1.4 Base material (masonry)

This ETAG applies to the use of injection anchors in masonry units of clay, calcium silicate, normal weight concrete and lightweight aggregate concrete (solid and hollow or perforated format blocks), autoclaved aerated concrete or other similar materials. As far as the specification of the different masonry units is concerned, EN 771-1 to 5:2011 [2] may be taken as reference. The design and construction of masonry structures in which the injection anchors are to be anchored shall be in accordance with EN 1996-1-1:2005 + AC:2009 [6] and the relevant national regulations.

Attention is drawn to the fact that the standards for masonry are not very restrictive with regard to details of units (e.g. type, dimensions and location of hollows, number and thickness of webs). Anchor resistance and load displacement behaviour, however, decisively depend on these influencing factors.

Usually solid masonry units do not have any holes or cavities other than those inherent in the material. However, solid units may have a vertical perforation or grip holes of up to 15 % of the cross section or frogs up to 20 % based on the volume of the brick. Therefore testing in solid material covers units with vertical perforation or grip holes of up to 15 % of the cross section or frogs up to 20 % based on the volume of the brick.

Masonry units consisting of hollow or perforated units have a certain volume percentage of voids which pass through the masonry unit. For the assessment of injection anchors anchored in hollow or perforated units it has also to be assumed that the anchor may be situated in solid material (e.g. joints, solid part of unit without holes) so that also tests in solid material may be required.

1.2 Intended use of the construction product

The injection anchors are intended to be used for anchorages for which requirements for mechanical resistance and stability and safety in use in the sense of the Essential Requirements N° 1 (ER1) and N° 4 (ER4) and, where applicable N° 2 (ER 2) and N° 3 (ER 3), of the CPD shall be fulfilled; failure of anchorages made with these products would cause an immediate risk to human life and/or possibly lead to considerable economic consequences. They are for fixing and/or supporting structural elements (which contribute to the stability of the works) or heavy units.

This ETAG applies only to anchors subject to static or quasi-static actions in tension, shear or combined tension and shear or bending. The anchors may be used in areas with very low seismicity according to EN 1998-1:2004 + AC:2009 [15].

This ETAG covers applications only where the masonry members in which the anchors are embedded are subject to static or quasi-static actions.

1.3 Assumed working life of the construction product

The provisions and the verification and assessment methods included or referred to in this ETAG have been written based upon the assumed working life of the injection anchors for the intended use of 50 years when installed in the works, provided that the injection anchors are subject to appropriate installation and use (see 4.3). These provisions are based upon the current state of the art and the available knowledge and experience.

"Assumed working life" means that, when an assessment following the ETAG provisions is made, and when this working life has elapsed, the real working life may be, in normal use conditions, considerably longer without major degradation affecting the Essential Requirements.

The indications of durability (linked to the working life) of the construction product cannot be interpreted as a guarantee given by the product manufacturer or his representative or the Approval Body issuing the ETA, but are regarded only as a means for choosing the appropriate products in relation to the expected economically reasonable working life of the works (see 5.2.2 of the Interpretative Documents).

1.4 Terminology

1.4.1 Common terms relating to the Construction Products Directive

For the meaning of these terms see EOTA document "Common terms used in Guidelines for European Technical Approval" published on the EOTA website.

1.4.2 Specific terms used in this ETAG

1.4.2.1 General

Anchor	=	a manufactured, assembled component including bonding materials for achieving anchorage between the base material (masonry) and the fixture.
Anchor group	=	several anchors (working together)
Fixture	=	component to be fixed to the masonry
Anchorage	=	an assembly comprising base material (masonry), anchor or anchor group and component fixed to the masonry.

1.4.2.2 Anchors

The notations and symbols frequently used in this Guideline are given below. Further particular notation and symbols are given in the text.

b	=	width of the member of the base material
c	=	edge distance towards the free edge of the brick (edge of the wall or vertical joint not to be filled with mortar)
c_{cr}	=	edge distance for ensuring the transmission of the characteristic resistance of a single injection anchor
c_{min}	=	minimum allowable edge distance
d	=	anchor bolt/thread diameter
d_0	=	drill hole diameter
d_{cut}	=	cutting diameter of drill bit
$d_{cut,m}$	=	medium cutting diameter of drill bit
d_f	=	diameter of clearance hole in the fixture
d_{nom}	=	outside diameter of anchor
h	=	thickness of masonry member (wall)
h_{min}	=	minimum thickness of masonry member
h_0	=	depth of cylindrical drill hole at shoulder
h_1	=	depth of drilled hole to deepest point
h_{ef}	=	effective anchorage depth
h_{nom}	=	overall anchor embedment depth in the masonry
l_{unit}	=	length of the masonry unit
h_{unit}	=	height of the masonry unit
s	=	spacing of the injection anchor
$s_{cr,N}$	=	spacing for ensuring the transmission of the characteristic resistance of a single injection anchor
$s_{cr,ll}$	=	s_{cr} horizontal joint
s_{cr}	=	s_{cr} horizontal joint
s_{min}	=	minimum allowable spacing
T	=	torque moment
T_{inst}	=	installation torque moment recommended by the manufacturer
T_u	=	maximum torque moment during failure
t_{fix}	=	thickness of fixture
t	=	thickness of outer web of the brick

1.4.2.3 Base materials (masonry) and metal parts of anchor

ρ	=	bulk density of masonry unit
f_b	=	normalised mean compressive strength of masonry unit
$f_{b,test}$	=	mean compressive strength of the test masonry unit at the time of testing
$f_{y,test}$	=	steel tensile yield strength in the test
f_{yk}	=	nominal characteristic steel yield strength
$f_{u,test}$	=	steel ultimate tensile strength in the test
f_{uk}	=	nominal characteristic steel ultimate strength

1.4.2.4 Loads/forces

F	=	force in general
N	=	normal force (+N = tension force)
V	=	shear force
M	=	moment
N_{Rk}, V_{Rk}	=	characteristic anchor resistance (5 %-fractile of results) under tension and shear force, respectively
$N_{Sd}^h (V_{Sd}^h)$	=	design value of tensile load (shear load) acting on the most stressed anchor of an anchor group

1.4.2.5 Tests

F_{Ru}^t	=	ultimate load in a test
$F_{Ru,m}^t$	=	mean ultimate load in a test series
F_{Rk}^t	=	5 %-fractile of the ultimate load in a test series
n	=	number of tests of a test series
v	=	coefficient of variation
$\delta(\delta_N, \delta_V)$	=	displacement (movement) of the anchor at the masonry surface relative to the masonry surface in direction of the load (tension, shear) outside the failure area. The displacement includes the steel and masonry deformations and a possible anchor slip.
α	=	ratio of test value / reference value, for instance

1.4.2.6 Temperature terms

Service temperature range: Range of ambient temperatures after installation and during the lifetime of the anchorage.

Short term temperature: Temperatures within the service temperature range which vary over short intervals, e.g. day/night cycles and freeze/thaw cycles.

Maximum short term temperature: Upper limit of the service temperature range.

Long term temperature: Temperature within the service temperature range, which will be approximately constant over significant periods of time. Long term temperatures will include constant or near constant temperatures, such as those experienced in cold stores or next to heating installations.

Maximum long term temperature: Specified by the manufacturer within the range of 0,6 times to 1,0 times the maximum short term temperature.

Normal ambient temperature: Temperature $21 \text{ °C} \pm 3 \text{ °C}$ (for test conditions only)

Open time: The maximum time from end of mixing to when the insertion of the anchor into the bonding material shall be completed.

Installation ambient temperature range: The environmental temperature range of the base material allowed by the manufacturer for installation.

Anchor component installation temperature range: The temperature range of the bonding material and embedded part immediately prior to installation.

Curing time: The minimum time from the end of mixing to the time when the anchor may be torqued or loaded (whichever is longer). The curing time depends on the ambient temperature.

1.5 Procedure in the case of a significant deviation from the ETAG

The provisions of this ETAG apply to the preparation and issue of European Technical Approvals in accordance with Article 9.(1) of the CPD and Section 3.1 of the Common Procedural Rules.

In cases in which a certain provision of this ETAG is not or not fully applicable or a particular aspect of a product and/or intended use to be assessed is not or not sufficiently covered by the methods and criteria of the ETAG, the procedure of Article 9.(2) of the CPD and Section 3.2 of the Common Procedural Rules may apply with regard to the deviation or aspect concerned.

2 ASSESSMENT OF FITNESS FOR USE

2.1 Meaning of "fitness for use"

"Fitness for (the intended) use" of a construction product means that the product has such characteristics that the **works** in which it is to be incorporated **can**, if properly designed and built,

1. **satisfy** the Essential Requirements when and where such works are subject to regulations containing such requirements (CPD Article 2.(1)) and
2. **be fit** for their intended use, account being taken of economy, **and** in this connection **satisfy** the Essential Requirements for an economically reasonable working life, if normally maintained (see CPD Annex I, sentence 1 and 2).

2.2 Elements of the assessment of fitness for use

The assessment of the fitness of a construction product for its intended use includes:

- the identification of the characteristics of the product which are relevant to its fitness for use (in the following referred to as "regulatory characteristics");
- the establishment of methods for the verification and assessment of the regulatory product characteristics and the expression of the respective product performances;
- the identification of such regulatory characteristics to which the option "No Performance Determined" applies for the reason that in one or more Member States they are not relevant for the fulfilment of the requirements applicable to the works;
- the identification of such regulatory characteristics for which limit values (threshold values) have to be respected for technical reasons.

2.3 Relationship of requirements to the product characteristics and methods of verification and assessment

2.3.1 Relationship of requirements to the product characteristics

The product characteristics, methods of verification and assessment criteria which are relevant for the fitness of injection anchors for the intended use referred to in 1.2 are given in Table 2.1.

Table 2.1 – Product characteristics and methods of verification and assessment

No	Product characteristic	Option "No Performance Determined"	Method of verification and assessment	Expression of product performance
(1)	(2)	(3)	(4)	(5)
Essential Requirement 1: Mechanical resistance and stability				
1	Suitability under normal site conditions: Requirements for an acceptable load/displacement behaviour, a certain ultimate load, a certain limited scatter	No	2.4.1 and 2.4.2	Influence factors on the load bearing behaviour of the anchor in accordance with the criteria of 2.4.2
2	Admissible service conditions: - load bearing behaviour of the anchor for tension/shear/ combined tension and shear/ bending - Required spacing and edge distance of the anchor - Minimum spacing and minimum edge distance of the anchor - Displacement for serviceability limit state of the anchor	No	2.4.1 and 2.4.2	2.4.2.2.3 - Characteristic resistance for tension/shear/ combined tension and shear/ bending - Characteristic spacing and edge distance of the anchor - Minimum spacing and minimum edge distance of the anchor - Displacement for serviceability limit state of the anchor
Essential Requirement 2: Safety in case of fire				
3	Reaction to fire	Yes (Class F)	2.5.1	Anchorage satisfy requirements for Class A1 (see 2.5.1)
4	Resistance to fire	No	2.5.2	Evaluation of the couple anchor-concrete (anchorage) concerning resistance to fire by tests or calculations
Essential Requirement 3: Hygiene, health and environment				
5	Content and/or release of dangerous substances	Yes	2.6	See the relevant chapter ²⁾
Essential Requirement 4: Safety in use				
6	The same criteria are valid as for Essential Requirement 1			
Essential Requirement 5: Protection against noise				
	None			
Essential Requirement 6: Energy economy and heat retention				
	None			
General aspects relating to fitness for use ¹⁾				
7	Suitability against environmental conditions	No	2.7.1	Resistance against environmental conditions
¹⁾ Aspects of durability and economy of the works (see CPD, Annex 1, sentences 1 and 2) which are not dealt with under Essential Requirements 1 to 6. Such aspects are also referred to as "serviceability". ²⁾ NPD option regarding ER3: For the meaning of the NPD option regarding ER3, see EOTA TR 034 "General Checklist for ETAGs/CUAPs/ETAs - Content and/or release of dangerous substances in products/kits" [18]				

2.3.2 Use categories

The Guideline applies to anchorages in respect of the following use categories:

2.3.2.1 Use categories in respect of the base material:

Use category **b**: Metal injection anchors for use in **solid¹⁾ masonry**

Use category **c**: Metal injection anchors for use in **hollow or perforated masonry**

Use category **d**: Metal injection anchors for use in **autoclaved aerated concrete masonry**

Each use category shall be given in the approval separately.

- ¹⁾ Covers also units with vertical perforation or grip holes of up to 15 % cross section or frogs up to 20 % based on the volume of the brick

2.3.2.2 Use categories in respect of installation and use:

Category **d/d** - **Installation and use** in structures subject to **dry**, internal conditions,

Category **w/d** - **Installation in** dry or **wet** substrate and **use** in structures subject to **dry**, internal conditions,

Category **w/w** - **Installation and use** in structures subject to dry or **wet** environmental conditions.

Each use category shall be given in the approval separately.

2.3.2.3 Use categories in respect of the service temperature range:

The functioning of an injection anchor, including its ability to continue to withstand its design load with an appropriate safety factor and to limit displacements, shall not be adversely affected by temperatures in the base material near to the surface within a temperature range to be specified by the manufacturer which may be either:

(Ta) - 40 °C to + 40 °C (max short term temperature + 40 °C and max long term temperature + 24 °C)

(Tb) - 40 °C to + 80 °C (max short term temperature + 80 °C and max long term temperature + 50 °C)

(Tc) on manufacturer's request with - 40 °C to T1 (short term: T1 > + 40 °C, long term: 0,6 T1 to 1,0 T1)

Injection anchors are not affected by service temperatures down to - 40 °C. If there is no experience for unknown bonding materials on their performance at - 40 °C then normal pull-out tests at - 40 °C will be required.

The performance shall not be adversely affected by short term temperatures within the service temperature range or by long term temperatures up to the maximum long term temperature.

Performance at the maximum long term temperature and maximum short term temperature is checked by tests described in 2.4.1.1.2

2.4 Product characteristics which are relevant for the fitness for use relating to Mechanical Resistance and Stability (ER 1)

2.4.1 Method of verification (General)

The tests involved in the assessment of injection anchors fall into 3 categories:

- (1) Tests for confirming their suitability (see 2.4.1.1)
- (2) Tests for evaluating the admissible service conditions (see 2.4.1.2)
- (3) Tests for checking durability (see 2.7.1)

The details of tests are given in Annex A.

It is assumed that for each injection anchor size there is only one anchorage depth. If the injection anchors are intended to be installed with two or more anchorage depths the tests have to be carried out at each depths.

2.4.1.1 Tests for suitability

The purpose of the suitability tests is to establish whether an anchor is capable of safe, effective behaviour in service including consideration of adverse conditions both during site installation and in service.

The types of suitability tests, test conditions, the number of required tests and the criteria applied to the results shall be taken in accordance with Table 2.4.2. Detailed information about special tests is given in the chapters after the table.

Table 2.4.1 – Base material for suitability tests for injection anchors to be used in masonry

	Purpose of test	Base material for use categories b and c		Base material for use category d
		Solid clay	Solid calcium silicate	Autoclaved aerated concrete
1a 1b	Installation safety	x	x	x
2a	Functioning, effect of increased temperature	x	x	x
2b 2c	Functioning, effect of installation temperature		(1)	x
3	Functioning under repeated loads		(1)	x
4a	Functioning under sustained loads (normal temperature)		(1)	x
4b	Functioning under sustained loads (max. long term temp.)		(1)	x
5	Maximum torque moment	Tests in all types of bricks as applied for		
6	Functioning under freeze/thaw condition	(1) (2)		
7	Checking durability of the bonding material	C20/25		

Notes to Table 2.4.1

- (1) Tests in solid clay masonry units or solid calcium masonry units, resulting from reference tests according to Table 2.4.4, line 1 (the maximum resistance is decisive). If the same injection system is already assessed in accordance with ETAG 001-5: Edition 2002. Amendment 2012 [17], the results of the relevant suitability tests (reduction factors) can also be used for anchors for use in masonry.
- (2) Tests in freeze-thaw resistant base material (see also 2.4.1.1.6).

Table 2.4.2 – Suitability tests for injection anchors to be used in masonry

	Purpose of test	Ambient base material Temperature	Minimum number of tests for anchor size (2)					Criteria		Test procedure suitability tests described in
			s	i	m	i	l	load/dis. behaviour	req. α (1)	
1	Installation in (a) dry substrate	normal	5	-	5	-	5	2.4.2 (c)	0,8	2.4.1.1.1a)
	(b) wet substrate (3)	normal	5	-	5	-	5	2.4.2 (c)	0,8	2.4.1.1.1b)
2	Functioning, effect of temperature (4)							2.4.2 (c)		2.4.1.1.2
	(a) increased temperature	+50 °C(5) +80 °C(5)			5				1,0 0,8 (6)	
	(b) low temperature	(4)			5				1,0	
	(c) minimum curing time	normal			5				0,9	
<i>More detailed description analogous Section 2.4.1.1.2.</i>										
3	Functioning under repeated loads	normal	-	-	5	-	-	2.4.2 (c)	1,0	2.4.1.1.3
4	Functioning under sustained loads	normal + 50 °C(5)	-	-	5	-	-	2.4.2 (c)	0,9	2.4.1.1.4
5	Maximum torque moment	normal	5	5	5	5	5			2.4.1.1.5
6	Functioning under freeze/thaw condition (7)	normal	-	-	5	-	-	2.4.2 (c)	0,9	2.4.1.1.6
7	Checking durability of the bonding material	see 2.7.1.2								

Notes to Table 2.4.2

- (1) If requirement is not met, corresponding provisions are given in 2.4.2.1
- (2) Anchor size: s = smallest; i = intermediate; m = medium; l = largest
If installation with sieve sleeve in solid bricks (or solid parts of bricks) is allowed in the ETA, the tests shall be done with sieve sleeve otherwise the tests shall be performed without sieve sleeve.
- (3) This test is not required for use category **d/d** (dry)
- (4) Minimum installation temperature as specified by the manufacturer; normally 0 °C to + 5 °C
- (5) For temperature range (Tb), for other temperature ranges see 2.3.2.3
- (6) Reference values from the tests with maximum long term temperature +50 °C for temperature range (Tb), for other temperature ranges see 2.3.2.3
- (7) For use category **w/w** only

2.4.1.1.1 Installation in dry or wet substrate

(a) Installation in dry substrate

Confined tension tests in dry solid masonry according to Annex A, A.5.4 a). These tests have to be performed for all use categories.

(b) Installation in wet substrate

Confined tension tests in wet solid masonry according to Annex A, A.5.4 b). These tests may be omitted for use category d/d.

2.4.1.1.2 Influence of temperature on characteristic resistances

(a) Effect of increased temperature

The confined tension tests shall be carried out according to Annex A, A.5.5 a) for the different temperature ranges given in 2.3.2.3.

(b) Effect of low installation temperature

The confined tension tests shall be carried out at the end of the curing time while maintaining the temperature of the test member at the specified lowest installation temperature ± 2 K. Details of the tests are described in Annex A, A.5.5 b).

(c) Minimum curing time at normal ambient temperature

Perform tension tests according to Annex A, A.5.5 c) at normal ambient temperature at the corresponding minimum curing time specified by the manufacturer.

2.4.1.1.3 Repeated loading

The injection anchor is subjected to 1×10^5 load cycles with a maximum frequency of approximately 6 Hz. After completion of the load cycles the anchor shall be unloaded, the displacement measured and a tension test performed according to Annex A. Details of the tests are described in Annex A, 5.6.

2.4.1.1.4 Sustained loading

The test is performed at normal temperature ($T = + 21 \text{ °C} \pm 3 \text{ °C}$) for temperature range (Ta), (Tb) and (Tc) and at maximum long term temperature for temperature range (Tb) and (Tc) [$T = + 50 \text{ °C}$ at minimum for temperature range (Tb)].

The anchor shall be installed at normal temperature and subjected to a tension (sustained) load. After completion of the sustained load test the anchor shall be unloaded, the displacement measured and immediately after unloading a tension test performed. Details of the tests are described in Annex A, A.5.7.

2.4.1.1.5 Maximum torque moment

The torque moment shall be measured with a calibrated torque moment transducer. The torque moment shall be increased until failure of the injection anchor. Details of the tests are described in Annex A, A.5.8.

2.4.1.1.6 Functioning under freeze/thaw conditions

In general the tests are carried out for injection anchors with a service condition in wet substrate only. The tests are performed in freeze-thaw resistant base material. The tests may also be carried out in freeze-thaw resistant concrete C50/60; in this case the corresponding reference tests are required in concrete under normal conditions as well.

The displacements shall be measured during the temperature cycles.

After completion of 50 cycles, carry out a tension test at normal ambient temperature. Details of the tests are described in Annex A, A.5.9.

2.4.1.2 Tests for evaluating the admissible service conditions

For determination of the admissible service conditions, the tests given in Table 2.4.3 shall be carried out.

If existing information is available from the manufacturer and the corresponding test report contains all relevant data, then the Approval Body may reduce the number of tests for admissible service conditions, making use of this existing information. However, it will be considered in the assessment only if the results are consistent with comparable test results available to the Approval Body.

All tests for determination of admissible service conditions shall be carried out according to Annex A in the base material for which the injection anchor is intended to be used.

The minimum edge distance c_{\min} and minimum spacing s_{\min} shall be given by the manufacturer and shall be confirmed by the corresponding tests.

The determined characteristic resistances for the approval are valid only for the bricks and blocks which are used in the tests regarding base material (masonry or aerated concrete), size of units, compressive strength and configuration of the voids. Therefore the following information has to be given in the test report and in the approval:

Base material, size of units, normalised compressive strength; volume of all holes (% of the gross volume); volume of any hole (% of the gross volume); minimum thickness in and around holes (web and shell); combined thickness of webs and shells (% of the overall width); appropriation to a group of Table 3.1 of EN 1996-1-1:2005 + AC:2009 [6].

As far as the specification of the different masonry units is concerned, EN 771-1 to 5:2011 [2] may be taken as reference.

In hollow or perforated masonry, anchorages in the end side of a wall (reveal) are covered only, if the tests include this setting position. Therefore this information has to be given in the test reports and in the approval.

Table 2.4.3 – Tests for admissible service conditions for injection anchors for use in masonry

	Purpose of test	Load direction	Distances	Member thickness h	Remarks	Number of tests			Test procedure described in Annex A
						s	m	l	
1	Reference tension tests for suitability tests (1)	N	$c = c_{cr}(3)$	h_{min}	Test with single anchors	5	5	5	Annex A, A.5.1, A.5.2
2	Characteristic resistance for tension loading not influenced by edge and spacing effects (2)	N	$c = c_{cr}(3)$	h_{min}	Test with single anchors (4)	5	5	5	Annex A, A.5.1, A.5.2
3	Characteristic resistance for shear loading not influenced by edge and spacing effects (2)	V	$c = c_{cr}(3)$	h_{min}	Test with single anchors (4)	5	5	5	Annex A, A.5.1, A.5.3
Optional tests									
4	Characteristic resistance for tension loading at minimum edge distance (5)	N	$c = c_{min}$	$= h_{min}$	Test with single anchors at the edge of test member	5	5	5	Annex A, A.5.1, A.5.2
5	Characteristic resistance for shear loading at minimum edge distance (6)	V	$c = c_{min}$	$= h_{min}$	Test with single anchors at the edge of test member	5	5	5	Annex A, A.5.1, A.5.3
6	Characteristic resistance for tension loading at minimum spacing (7)	N	$s = s_{min}$ $c = c_{min}$	$= h_{min}$	Test with double / quadruple anchor group (8) at the edge of test	5	5	5	Annex A, A.5.1, A.5.2
7	Characteristic resistance for shear loading at minimum spacing (7)	V	$s = s_{min}$ $c = c_{min}$	$= h_{min}$	Test with double / quadruple anchor group (8) at the edge of test member	5	5	5	Annex A, A.5.1, A.5.3

Notes to Table 2.4.3

- (1) Reference tension tests for determination of the results of the suitability tests. They have to be carried out on the same masonry units regarding base material, size of units and compressive strength as used for the corresponding suitability tests. They have to be performed with the same anchor configuration (e.g. size, sieve sleeve) as used for the corresponding suitability tests.

If the results of the reference tests are smaller than the results of the tests for characteristic resistance, the reference tests shall be considered for evaluating of the characteristic resistance.

- (2) The tests shall be carried out at the most unfavourable setting position in the brick of hollow or perforated masonry, which give the lowest characteristic resistance of the anchor. For example, if hollow brick consists of thick webs or shells, the anchor shall be tested in the hole as well as in the massive parts of the brick.

For the intended use in plastered masonry (the joints are not visible) additional tests in joints not filled with mortar are necessary, if the drilling diameter is smaller than 15 mm. If such products are not tested and assessed, the relevant ETA shall allow the use only if the setting position in a joint only can be excluded (e.g. removal of the plaster around the installation position).

- (3) For characteristic edge distances the following distances may be used (standard values):

Anchorage in solid masonry and AAC: $c_{Cr} = 1,5 h_{ef}$
Anchorage in hollow or perforated masonry: $c_{Cr} = \max(100 \text{ mm}; 6 d_0)$

If the manufacturer accepts these standard values c_{Cr} as the minimum value c_{min} , tests on the free edge can be omitted.

- (4) For determination of a group of two or four injection anchors the following spacing may be used (standard values):

Anchorage in solid masonry and AAC: $s_{Cr} = 3,0 h_{ef}$
Anchorage in hollow or perforated masonry: $s_{Cr,II} = l_{unit}$ (s_{Cr} II horizontal joint)
 $s_{Cr,}$ = h_{unit} (s_{Cr} horizontal joint)

If the manufacturer accepts these standard values s_{Cr} as the minimum value s_{min} , tests with anchor groups can be omitted.

- (5) Tension tests with single anchors near the free edge of a wall to determine the characteristic resistance depending on the minimum edge distance c_{min} . These tests can be omitted, if for c_{min} the value c_{Cr} is accepted.
- (6) Shear tests with single anchors in direction to the free edge of a wall to determine the characteristic resistance depending on the minimum edge distance c_{min} . This test can be omitted, if the resistance calculated according to Annex C, C.5.2.2.5 is accepted.
- (7) The spacing s_{min} may also be evaluated by appropriate tests with an anchor group of two anchors with $s_{min,II}$ and/or $s_{min,}$ and/or with an anchor group of four anchors with $s_{min,II}$ and/or $s_{min,}$. s_{min} shall be given in the approval (spacing of a group of anchors in the tests)

The spacing s_{min} shall be greater than the following values:

Anchorage in solid masonry and AAC: $s_{min} \geq \max(50 \text{ mm}; 3 d_0)$
Anchorage in hollow or perforated masonry: $s_{min} \geq \max(75 \text{ mm}; 5 d_0)$
This test may be omitted if for s_{min} the value s_{Cr} is accepted.

- (8) Double and/or quadruple anchor group depend on the application of the manufacturer. The tested configuration will be given in the ETA.

2.4.2 Method of assessing and judging (general)

This sub-clause details the assessing and judging of the injection anchors related to the intended use, using the verification methods of 2.4.1.

(a) 5%-fractile of the ultimate loads

The 5%-fractile of the ultimate loads measured in a test series is to be calculated according to statistical procedures for a confidence level of 90 %. If a precise verification does not take place, a log normal distribution and an unknown standard deviation of the population shall be assumed.

$$F_{5\%} = \bar{F} (1 - k_s \cdot v) \quad (2.4.1)$$

e.g.: $n = 5$ tests: $k_s = 3,40$
 $n = 10$ tests: $k_s = 2,57$

(b) Conversion of ultimate loads to take account of masonry and steel strength

Masonry unit strength:

In some cases it can be necessary to convert the results of a test series to correlate with a unit strength different from that of the test unit. In the case of unit failure, this conversion shall be carried out according to Equation (2.4.2)

$$F_{Ru}(f_b) = F_{Ru}^t \cdot \left(\frac{f_b}{f_{b,test}} \right)^\alpha \quad (2.4.2)$$

with:

$F_{Ru}(f_b)$ = failure load at unit compressive strength f_b
 α = 0,5 for masonry units of clay or concrete and solid unit of calcium silicate
 α = 0,75 for masonry units of perforated calcium silicate (in this connection the range in the unit strength in the tests is limited to ± 100 % of the nominal strength of the unit for the characteristic resistance)
 $f_{b,test}$ = mean compressive strength of the masonry unit at the time of testing with $f_{b,test} > f_b$ (if $f_{b,test} < f_b$, then $f_{b,test}$ or the next smaller strength class f_b shall be given in the approval)

In the case of pull-out failure the influence of the unit strength on the failure load shall be established. In the absence of better information, Equation (2.4.2) may be used as an approximation.

Autoclaved aerated concrete units strength:

General:

The tests results shall be converted as far as compressive strength and dry density are concerned.

Compressive strength:

For AAC blocks the characteristic compressive strength shall be determined from the declared value of compressive strength according to EN 771-4: using the factor of 0,9.

$$f_{ck} = 0,9 f_{c,decl}$$

Dry density:

As reference values of dry density the following minimum values of dry density shall be used for low and high strength AAC for conversion of the test results:

low strength AAC: $\rho_{min} = 350 \text{ kg/m}^3$
high strength AAC: $\rho_{min} = 650 \text{ kg/m}^3$

Conversion of test results:

The test results obtained for low and high strength AAC shall be converted using the following Equation:

$$F_{Ru}^{t_k} = F_{Ru}^t \cdot \frac{\rho_{min}^{3/4} \cdot f_{ck}}{\rho_{test}^{3/4} \cdot f_{c,test}} \quad (\text{kN}) \quad (2.4.3)$$

From the above, the 5 %-fractile for the ultimate load shall be derived.

Characteristic failure load (ultimate load) of the different strength of AAC:

For the strength between low and high strength AAC the characteristic failure loads shall be determined by linear interpolation of the converted test results.

Steel strength:

In case of steel failure the failure load shall be converted to the nominal steel strength by Equation (2.4.4)

$$F_{Ru}(f_{uk}) = F_{Ru}^t \cdot \frac{f_{uk}}{f_{u,test}} \quad (2.4.4)$$

with:

$F_{Ru}(f_{uk})$ = failure load at nominal characteristic steel ultimate strength

(c) In all tests the following criteria shall be met:

- (1) In all tension tests the load-displacement curves shall show a steady increase (see Figure 2.4); uncontrolled slip of injection anchors is not allowed.

Solid masonry units (bond between steel element, injection mortar and masonry)

Uncontrolled slip occurs when the mortar with the embedded part is pulled out of the drilled hole (because then the load displacement behaviour depends significantly on irregularities of the drilled hole). The corresponding load when uncontrolled slip starts is called load at loss of adhesion $N_{u,adh}$. For the requirement on the load-displacement curves with respect to uncontrolled slip the following evaluation shall be done:

$N_{u,adh}$ shall be evaluated for every test from the measured load displacement curve. In general the load at loss of adhesion is characterised by a significant change of stiffness, see Figure 2.4 a. If the change in stiffness at a defined load is not so obvious e.g. the stiffness is smoothly decreasing, than the load at loss of adhesion shall be evaluated as follows:

- 1) Compute the tangent to the load-displacement curve at a load $0,3 N_u$ (N_u = peak load in test). In general the tangent stiffness can be taken as the secant stiffness between the points $0/0$ and $0,3 N_u/\delta_{0,3}$ ($\delta_{0,3}$ = displacement at $N = 0,3 N_u$).
- 2) Divide the tangent stiffness by a factor of 1,5.
- 3) Draw a line through the point $0/0$ with the stiffness as calculated in 2).
- 4) The point of intersection between this line and the measured load-displacement curve gives the load $N_{u,adh}$ where the adhesion fails, see Figure 2.4 b.

If there is a peak in the load-displacement curve to the left side of this line which is higher than the load at intersection then $N_{u,adh}$ is taken as the peak load, see Figure 2.4 c.

If there is a very stiff load-displacement curve at the beginning ($\delta_{0,3} \leq 0,05\text{mm}$) then the drawing of the line for the calculation can be shifted to the point $(0,3 N_u/\delta_{0,3})$, see Figure 2.4 d.

For all tests, the factor α_1 shall be calculated according to Equation (2.4.5a):

$$\alpha_1 = \frac{N_{u,adh}}{0,5 \cdot N_{Ru}} \quad (2.4.5a)$$

with: $N_{u,adh}$ = load at loss of adhesion as defined above
 N_{Ru} = maximum load of single test

The minimum value of α_1 of all tests is decisive. If the value of α_1 is less than 1,0 then the characteristic resistance $N_{Rk,p}$ shall be reduced according to 2.4.2.2.3.

The evaluation of the load at loss of adhesion is not required when failure occurs between mortar and embedded part along the entire embedment depth (see definition of uncontrolled slip). In this case the factor α_1 may be taken as 1,0.

Hollow or perforated masonry units and solid masonry with open structure (porous) material (mechanical interlock of the mortar with parts of the masonry)

Uncontrolled slip is characterised by a significant change of stiffness according to Figure 2.5. The corresponding load when uncontrolled slip starts is called N_1 .

For all tests, the factor α_1 shall be calculated according to Equation (2.4.5b):

$$\alpha_1 = \frac{N_1}{0,5 \cdot N_{Ru}} \quad (2.4.5b)$$

with: N_1 = load at which uncontrolled slip of the anchor occurs (see Figure 2.5)
 N_{Ru} = maximum load of single test

The minimum value of α_1 of all tests is decisive. If the value of α_1 is less than 1,0 then the characteristic resistance $N_{Rk,p}$ shall be reduced according to 2.4.2.2.3.

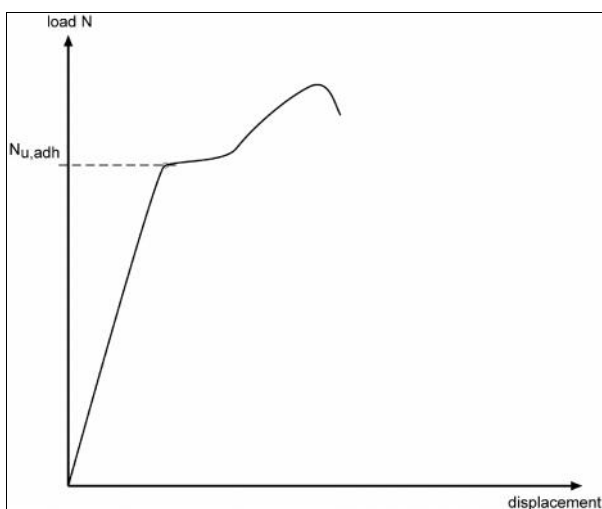

a) load at loss of adhesion by a significant change of stiffness

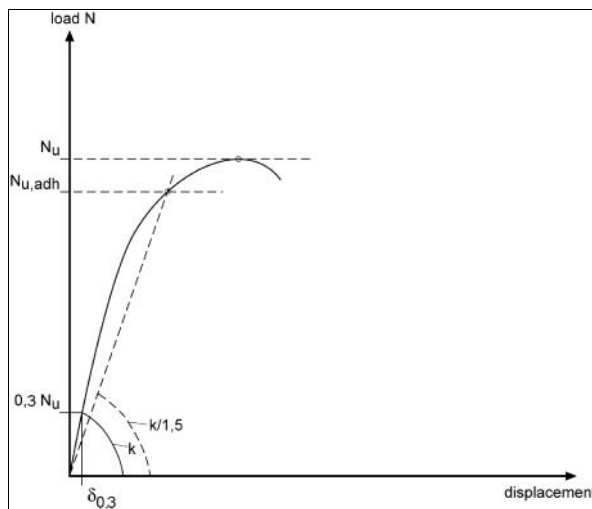

b) evaluation of load at loss of adhesion

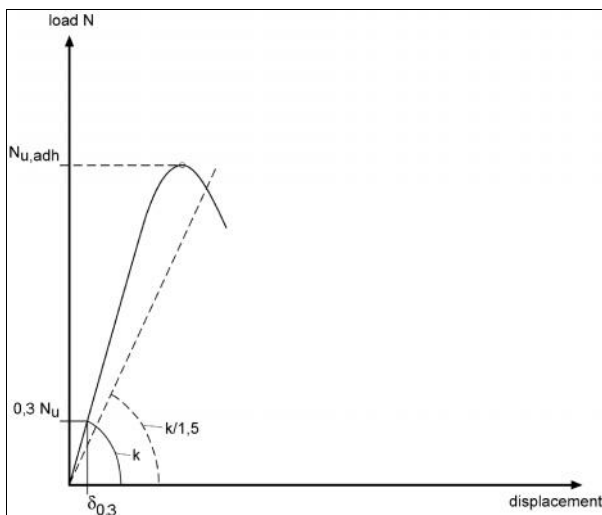

c) evaluation of load at loss of adhesion

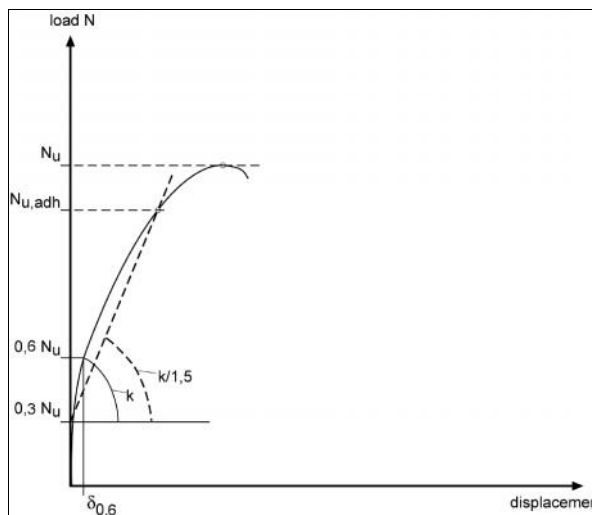

d) evaluation of load at loss of adhesion

Figure 2.4 – Examples of load-displacement curves (solid masonry)

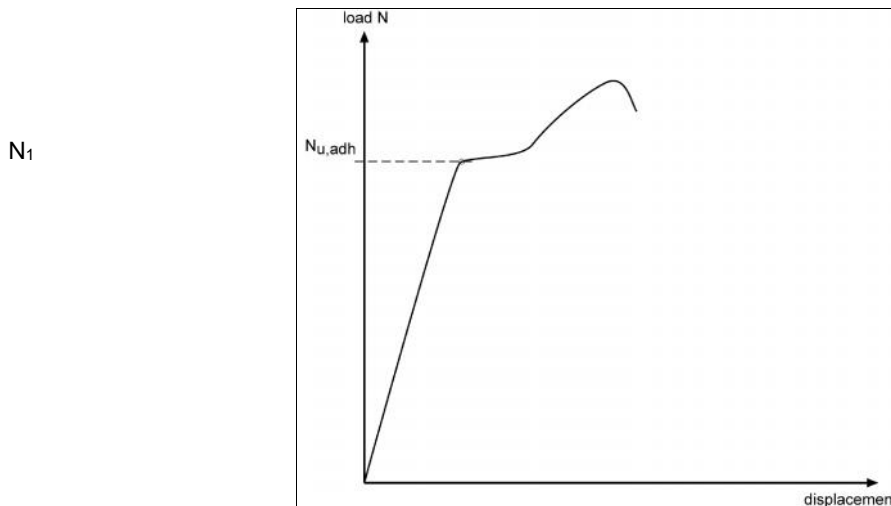

Figure 2.5 – Example of load-displacement curve (hollow or perforated masonry)

- (2) In general, in each test series, the coefficient of variation of the ultimate load shall be smaller than $v = 30\%$ in the suitability tests and $v = 20\%$ in the admissible service condition tests.

If the coefficient of variation of the ultimate load in the suitability test is greater than 30 %, then the following α_v -value has to be taken into account:

$$\alpha_v = \frac{1}{1 + 0,03 \cdot (v[\%] - 30)} \leq 1,0 \quad (2.4.6)$$

If the coefficient of variation of the ultimate load in the admissible service condition test is greater than 20 %, then the following α_v -value has to be taken into account:

$$\alpha_v = \frac{1}{1 + 0,03 \cdot (v[\%] - 20)} \leq 1,0 \quad (2.4.7)$$

- (3) If in the tests under shear loading displacements higher than 20 mm occur, then the load at a displacement of 20 mm shall be evaluated.

2.4.2.1 Additional criteria valid for suitability tests

In the suitability tests the factor α shall be larger than the value given in Table 2.4.2:

$$\alpha = \text{lesser value of } \frac{N_{Ru,m}^t}{N_{Ru,m}^r} \quad (2.4.8)$$

$$\text{and } \frac{N_{Rk}^t}{N_{Rk}^r} \quad (2.4.9)$$

with:

$N_{Ru,m}^t$; N_{Rk}^t = mean value or 5 %-fractile, respectively, of the ultimate loads in a test series

$N_{Ru,m}^r$; N_{Rk}^r = mean value or 5 %-fractile, respectively, of failure loads in the reference tests.

Reference tests have to be carried out on the same masonry units regarding base material, size of units and compressive strength as used for the corresponding suitability tests.

Equation (2.4.9) is based on test series with a comparable number of test results in both series. If the number of tests in the two series is very different, then Equation (2.4.9) may be omitted when the coefficient of variation of the test series is smaller than or equal to the coefficient of variation of the reference test series or if the coefficient of variation in the suitability tests is $v \leq 15\%$.

If the criterion for the required value of α (see Table 2.4.2) is not met in a test series, then the factor α_2 shall be calculated.

$$\alpha_2 = \frac{\alpha}{\text{req.}\alpha} \quad (2.4.10)$$

with:

α lowest value according to Equation (2.4.8 or 2.4.9) in the test series
 $\text{req.}\alpha$ required value of α according to Table 2.4.2

2.4.2.1.1 Installation in dry or wet substrate

The required α in the tests is $\geq 0,8$. If the requirements concerning α are not fulfilled, α_2 shall be calculated according to Equation (2.4.10).

2.4.2.1.2 Influence of temperature on characteristic resistances

a) Effect of increased temperature

The required α for the tests at maximum long term temperature is:

$\text{req.}\alpha \geq 1,0$ for temperature ranges (Tb) ($T = + 50 \text{ }^\circ\text{C}$) and (Tc) ($0,6 T_1$ to $1,0 T_1$, chosen by the manufacturer)

The required α for the maximum short term temperature are:

$\text{req.}\alpha \geq 0,8$ of the results of maximum long term temperature ($24 \text{ }^\circ\text{C}$ for temperature range Ta)
 $\text{req.}\alpha \geq 0,8$ of the results of maximum long term temperature ($50 \text{ }^\circ\text{C}$ for temperature range Tb)
 $\text{req.}\alpha \geq 0,8$ of the results of maximum long term temperature ($0,6 T_1$ to $1,0 T_1$ temperature chosen by the manufacturer for temperature range Tc)

If the requirements concerning α are not fulfilled in the tests at the maximum long term or maximum short term temperature, α_2 shall be calculated according to Equation (2.4.10).

b) Effect of low installation temperature

The required α for the tests at the minimum installation temperature is 1,0.

If this condition is not fulfilled, then the minimum installation temperature shall be increased and the tests at minimum installation temperature shall be repeated until the condition is fulfilled.

c) Minimum curing time at normal ambient temperature

The mean failure loads and the 5% fractile of failure loads measured in tests at the normal ambient temperature and corresponding minimum curing time shall be at least 0,9 times to the values measured in reference tests with a "long curing time" in the tests for admissible service conditions. The "long curing time" is the maximum curing time normally used in admissible service condition tests (24 hours for resins, 14 days for cementitious-mortars).

If this condition is not fulfilled, then the minimum curing time at normal ambient temperature shall be increased and the corresponding tests shall be repeated or the characteristic resistance for pull-out failure given in the ETA reduced according to Equation (2.4.10).

2.4.2.1.3 Repeating loading

The increase of displacements during cycling shall stabilise in a manner indicating that failure is unlikely to occur after some additional cycles. This condition may be assumed as fulfilled if the displacements after cycling at max N of the test are smaller than the mean value of the displacements at overcoming loss of adhesion in the reference tests.

If the above condition on the displacement is not fulfilled, the tests have to be repeated with a lower maximum load (max N) until this condition is fulfilled. Then the characteristic resistance N_{Rk} shall be reduced by the factor $\text{max N (applied)} / \text{max N (required)}$.

The required α for the pull-out tests subsequent to the cycling loading is 1,0. If this condition is not fulfilled, α_2 shall be calculated according to Equation (2.4.10).

2.4.2.1.4 Sustained loading

The displacements measured in the tests have to be extrapolated according to Equation (2.4.11) (Findley approach) to 50 years (tests at normal ambient temperature), or 10 years (tests at maximum long term temperature).

The curve fitting shall start with the displacement measured after approximately 100 h.

$$s(t) = s_0 + a \cdot t^b \quad (2.4.11)$$

s_0 = initial displacement under the sustained load at $t = 0$ (measured directly after applying the sustained load)

a, b = constants (tuning factors), evaluated by a regression analysis of the deformations measured during the sustained load tests

The extrapolated displacements shall be less than the mean value of the displacements at the load at overcoming loss of adhesion in the reference tests.

If this condition is not fulfilled, the tests have to be repeated with a lower load N_p until the requirement is fulfilled and the characteristic resistance shall be reduced by the factor N_p (applied) / N_p (required).

The failure loads measured in the pull-out tests subsequent to the sustained loading at normal temperature shall be compared with the failure loads measured in the reference tension tests (Table 2.4.3, line 1).

The failure loads measured in the pull-out tests subsequent to the sustained loading at maximum long term temperature shall be compared with the failure loads measured in the suitability tests at maximum long term temperature (Table 2.4.2, line 2(a)).

The required α is 0,9. If this condition is not fulfilled for residual capacity after sustained loading at normal temperature and maximum long term temperature, α_2 shall be calculated according to Equation (2.4.10).

2.4.2.1.5 Maximum torque moment

The installation of the injection anchor shall be practicable without steel failure, turn-through in the hole or failure of the anchorage.

This condition may be assumed to be fulfilled if the following conditions are met. The ratio of the maximum torque moment T_u during failure to the installation moment T_{inst} recommended by the manufacturer shall be determined for every test. The 5 %-fractile of the ratio for all tests shall be at least 2,1. The conversion to the nominal masonry strength may be omitted for these determinations.

2.4.2.1.6 Functioning under freeze/thaw conditions

The rate of displacement increase shall be reduced with increasing number of freeze/thaw cycles to a value almost equal to zero.

2.4.2.2 Criteria for admissible service conditions tests

2.4.2.2.1 General

In all tension tests, the requirement for the load/displacement curves shall satisfy the requirements laid down in 2.4.2 c (1). The requirements on the coefficient of variation of the ultimate loads are given in 2.4.2 c (2).

2.4.2.2.2 Characteristic resistance of a single anchor for the different conditions

The characteristic resistances of the injection anchor for the different failure modes under tension and shear loading shall be evaluated by the corresponding tests to get the required values for the design method according to Annex C.

2.4.2.2.3 Characteristic resistance of a single anchor in the ETA

The characteristic resistances of single anchors without-spacing effects under tension loading shall be calculated as follows:

$$N_{Rk,p} = N_{Rk,b} = N_{Rk,0} \cdot \min^1 (\min \alpha_1 ; \min \alpha_{2, \text{line 1,3,4,6}}) \cdot \min \alpha_{2, \text{line 2}} \cdot \min \alpha_3 \cdot \min \alpha_{V,N} \quad (2.4.12)$$

¹⁾ The lowest value of $\min r_1$ or $\min r_{2, \text{line 1,3,4,6}}$ is used.

with:

$N_{Rk,p}$	=	characteristic resistance of pull out failure of the anchor
$N_{Rk,b}$	=	characteristic resistance of brick break out failure
$N_{Rk,0}$	=	minimum characteristic resistance evaluated from the results of tests according to Table 2.4.3, line 2 and Table 2.4.3, line 4
$\min \alpha_1$	=	minimum value α_1 (reduction factor from the load/displacement behaviour) according to Equation (2.4.5) of all tests ($\leq 1,0$)
$\min \alpha_{2, \text{line 2}}$	=	minimum value α_2 (reduction factor from the ultimate loads in the suitability tests) according to Equation (2.4.10) of suitability tests according to Table 2.4.2, line 2 (temperature) ($\leq 1,0$)
$\min \alpha_{2, \text{line 1,3,4,6}}$	=	minimum value α_2 (reduction factor from the ultimate loads in the suitability tests) according to Equation (2.4.10) of suitability tests according to Table 2.4.2, line 1, 3, 4 and 6 ($\leq 1,0$)
$\min \alpha_{V,N}$	=	minimum value α_V to consider a coefficient of variation of the ultimate loads in the suitability and admissible service condition tension tests (according to Table 2.4.3, line 1, 2, 4 and 6) larger than 30 % or 20 %, respectively, Equations (2.4.6) and (2.4.7).
$\min \alpha_3$	=	minimum value α_3 (reduction factor from the durability behaviour) according to Equation (2.7.1) of all tests ($\leq 1,0$)

The characteristic resistances of single anchors without spacing effects under shear loading shall be calculated as follows:

$$V_{Rk,b} = V_{Rk,0} \cdot \min \alpha_1 \cdot \min \alpha_{V,V} \quad (2.4.13)$$

with:

$V_{Rk,b}$	=	characteristic resistance of local brick failure independent of the failure mode
$V_{Rk,0}$	=	minimum characteristic resistance evaluated from the results of tests according to Table 2.4.3, line 3 and Table 2.4.3, line 5
$\min \alpha_1$	=	minimum value α_1 (reduction factor from the load/displacement behaviour) according to Equation (2.4.5) of all tests ($\leq 1,0$)
$\min \alpha_{V,V}$	=	minimum value $\alpha_{V,V}$ to consider a coefficient of variation of the ultimate loads in the admissible service condition shear tests (according to Table 2.4.3, line 3, 5 and 7) larger than 20 %, Equations (2.4.7).

In case of steel failure in the tests according to Table 2.4.3, line 3, $V_{Rk,s}$ (characteristic resistance of steel failure of the anchor) according to Equation (2.4.13) shall be considered additionally. The minimum value of $V_{Rk,s}$ according to Equation (C.5.5) and $V_{Rk,s}$ according to Equation (2.4.13) shall be given in the approval.

The value of the characteristic resistance F_{Rk} , $N_{Rk,p}$, $N_{Rk,b}$, $V_{Rk,s}$, $V_{Rk,b}$ shall be rounded down to the following numbers:

0,3 / 0,4 / 0,5 / 0,6 / 0,75 / 0,9 / 1,2 / 1,5 / 2 / 2,5 / 3 / 3,5 / 4 / 4,5 / 5 / 5,5 / 6 / 6,5 / 7 / 7,5 / 8 / 8,5 / 9 / 9,5 / 10 / 10,5 / 11 / 11,5 / 12 kN

The determined characteristic resistances for the approval are valid only for the bricks and blocks which are used in the tests regarding base material, size of units, compressive strength and configuration of the voids. Therefore the following information has to be given in the test report and in the approval:

Base material, size of units, normalised compressive strength; volume of all holes (% of the gross volume); volume of any hole (% of the gross volume); minimum thickness in and around holes (web and shell); combined thickness of webs and shells (% of the overall width); appropriation to a group of Table 3.1 of EC 6.

The characteristic resistance of the injection anchor may be determined by "job site tests" according to Annex B, if the anchor has an approval with characteristic values for the same type of base material (e.g. clay, calcium silicate, lightweight aggregate or autoclaved aerated concrete) as is present on the construction works. Furthermore job site tests for use in solid masonry are possible only if the injection anchor has an approval for use in solid masonry and job site tests for use in hollow or perforated masonry are possible only if the metal injection anchor has an approval for use in hollow or perforated masonry.

If the characteristic resistance of the injection anchor may be determined by "job site tests" according to Annex B, the β factor to consider the different influences of the product shall be calculated as follows and shall be given in the ETA.

$$\beta = \min(\min \alpha_1 ; \min \alpha_{2, \text{line 1,3,4,6}}) \cdot \min \alpha_{2, \text{line 2}} \cdot \min \alpha_3 \cdot \min \alpha_{V,N} \quad (2.4.14)$$

$$\min \alpha_1, \min \alpha_{2, \text{line 2}}, \min \alpha_{2, \text{line 1,3,4,6}}, \min \alpha_{V,N}, \min \alpha_3 \quad \text{see Equation (2.4.12)}$$

2.4.2.2.4 Displacement behaviour

As a minimum, the displacements under short and long term tension and shear loading shall be given in the approval for a tension or shear load F which corresponds to the value according to Equation (2.4.13).

$$F = \frac{F_{Rk}}{\gamma_F \cdot \gamma_M} \quad (2.4.15)$$

with:

$$\begin{aligned} F_{Rk} &= \text{characteristic resistance } N_{Rk,p}, N_{Rk,b} \text{ for displacements under tension load acc. to 2.4.2.2.3} \\ F_{Rk} &= \text{characteristic resistance } V_{Rk,s} \text{ or } V_{Rk,b} \text{ for displacements under shear load acc. to 2.4.2.2.3} \\ F_{Rk} &= \text{characteristic resistance according to 2.4.2.2.3} \\ \gamma_F &= 1,4 \\ \gamma_M &= \text{corresponding material partial safety factor} \end{aligned}$$

The displacements under short term tension loading (δ_{NO}) are evaluated from the tests with single anchors without edge or spacing effects according to Table 2.4.3, line 2. The value derived shall correspond to the 95 %-fractile for a confidence level of 90 %.

The long term tension loading displacements $\delta_{N\infty}$ may be assumed to be equal to 2,0 times the value δ_{NO} .

The displacements under short term shear loading (δ_{VO}) are evaluated from the corresponding shear tests with single anchors. The value derived shall correspond to the 95 %-fractile for a confidence level of 90 %.

The long term shear loading displacements $\delta_{V\infty}$ may be assumed to be equal to 1,5 times the value δ_{VO} .

Under shear loading, the displacements might increase due to a gap between fixture and anchor. The influence of this gap is taken into account in design.

2.4.2.2.5 Characteristic resistance of an anchor group in the ETA

The characteristic resistances of a double or quadruple anchor group under tension loading shall be calculated as follows:

$$N_{Rk}^g = \alpha_{g,N} \cdot N_{Rk} \quad (2.4.16)$$

with:

$$\begin{aligned} N_{Rk}^g &= \text{characteristic resistance of the anchor group under tension loading and under defined spacing } s_{\text{min,II}} \text{ and/or } s_{\text{min}}, \text{ and under defined edge distances } c_{\text{min}}, \text{ given in the approval} \\ N_{Rk} &= N_{Rk,p} \text{ or } N_{Rk,b} \text{ according to Equation (2.4.12)} \\ \alpha_{g,N} &= \text{smaller value of } \frac{N_{Ru,m}^{t,g}}{N_{Ru,m}^r} \text{ and } \frac{N_{Rk}^{t,g}}{N_{Rk}^r}, \\ &\text{group factor for tension loading, shall be rounded to 0,05} \\ &\quad 2 \text{ (for double anchor groups)} \\ &\quad 4 \text{ (for quadruple anchor groups)} \end{aligned}$$

$N_{Ru,m}^{t,g}$; $N_{Rk}^{t,g}$ = mean value or 5 %-fractile of the ultimate loads of an anchor group in a test series according to Table 2.4.3, line 6

$N_{Ru,m}^r$; N_{Rk}^r = mean value or 5 %-fractile of ultimate loads of a single anchor in the relevant reference test according to Table 2.4.3, line 2 (if $c_{min} = c_{cr}$) or line 4 (if this optional test is performed)

The characteristic resistances of a double or quadruple anchor group under shear loading shall be calculated as follows:

$$V_{Rk}^g = \alpha_{g,V} \cdot V_{Rk} \quad (2.4.17)$$

with:

V_{Rk}^g = characteristic resistance of the anchor group under shear loading and under defined spacing $s_{min,II}$ and/or s_{min} , and under defined edge distances c_{min} , given in the approval

V_{Rk} = $V_{Rk,b}$ according to Equation (2.4.13)

$\alpha_{g,V}$ = smaller value of $\frac{V_{Ru,m}^{t,g}}{V_{Ru,m}^r}$ and $\frac{V_{Rk}^{t,g}}{V_{Rk}^r}$,

group factor for shear loading, shall be rounded to 0,05
2 (for double anchor groups)
4 (for quadruple anchor groups)

$V_{Ru,m}^{t,g}$; $V_{Rk}^{t,g}$ = mean value or 5 %-fractile of the ultimate loads of an anchor group in a test series according to Table 2.4.3, line 7

$V_{Ru,m}^r$; V_{Rk}^r = mean value or 5 %-fractile of ultimate loads of a single anchor in the relevant reference test according to Table 2.4.3, line 3 (if $c_{min} = c_{cr}$) or line 5 (if this optional test is performed)

In general, a linear interpolation between the characteristic resistance of a single anchor and the characteristic resistance of an anchor group depending on the spacing is not allowed. If there are sufficient test results with anchor groups in the same masonry units available, which show a clear dependency between the load-bearing capacity and the anchor spacing and/or the edge distance, it is possible to evaluate them and to take them into account in the approval.

2.5 Verification methods relating to Safety in Case of Fire (ER 2)

2.5.1 Reaction to fire

The reaction to fire performance of the anchor shall be in accordance with laws, regulations and administrative provisions applicable to the anchor in its intended end use application. This performance shall be expressed in the form of classification specified in accordance with the relevant EC decision and the appropriate CEN classification standards.

The metal parts of injection anchors and the cementitious mortar are assumed to satisfy the requirements for Class A1 of the characteristic reaction to fire, in accordance with the provisions of EC Decision 96/603/EC (as amended) without the need for testing on the basis of its listing in that Decision.

The bonding material (synthetic mortar, cementitious mortar or a mixture of the two including fillers and/or additives) is located between the metal anchor rod and the wall of the drilled hole in the end use. The thickness of the mortar layer is about 1 to 2 mm and most of the mortar is material classified class A1 according to EC Decision 96/603/EC. Therefore it may be assumed that the bonding material (synthetic mortar or a mixture of synthetic mortar and cementitious mortar) in connection with the injection anchor in the end use application do not make any contribution to fire growth or to the fully developed fire and they have no influence to the smoke hazard.

In the context of this end use application of the anchorages the bonding material can be considered to satisfy any reaction to fire requirements.

2.5.2 Resistance to fire

The resistance to fire performance of the assembled system of which the anchor form part shall be in accordance with laws, regulations and administrative provisions applicable to the assembled system of which the anchor form part in its intended end use application. This performance shall be expressed in the form of a classification specified in accordance with the relevant EC decision and the appropriate CEN classification standards.

The suitability of a injection anchor for use in a system that is required to provide a specific fire resistance class, shall be assessed according to the EOTA Technical Report N° 020 "Evaluation of anchorages in concrete concerning Resistance to Fire" [7].

2.6 Verification methods relating to Hygiene, Health and the Environment (ER 3)

The applicant shall either:

- submit the chemical constitution and composition of the materials and components of the product to the Approval Body which will observe strict rules of confidentiality
or
- submit a written declaration to the Approval Body stating whether or not and in which concentration the materials and components of the product contain substances which have to be classified as dangerous according to Directive 67/548/EEC and Regulation (EC) No 1272/2008 and listed in the "Indicative list on dangerous substances" of the EGDS, taking into account the installation conditions of the construction product and the release scenarios resulting from there.

The use of recycled materials shall always be indicated, because this could lead to the implementation of further assessment and verification methods.

The information concerning the presence of dangerous substances listed in Council Directive 67/548/EEC and Regulation (EC) No 1272/2008 regulated at European level and listed in the "Indicative list on dangerous substances" of the EGDS and/or of other dangerous substances, shall be circulated as part of the evaluation report by the issuing Approval Body to the other Approval Bodies, under strict conditions of confidentiality.

2.6.1 Method of verification (Release of dangerous substances)

The product and/or constituents of the product listed in the EOTA TR 034: "General Checklist for ETAGs/CUAPs/ETAs – Content and/or release of dangerous substances in products/kits", which have to be considered will be verified by the given methods taking into account the installation conditions of the construction product and the release scenarios resulting from there. Regulations related to placing the product on the market may also need to be taken into account.

Regarding the release scenarios referred to in the EOTA TR 034, the use category IA2 (Product with no direct contact to (e.g. covered products) but possible impact on indoor air) have to be considered.

2.6.2 Method of assessing and judging (Release of dangerous substances)

The product and/or constituents of the product listed in the EOTA TR 034: "General Checklist for ETAGs/CUAPs/ETAs – Content and/or release of dangerous substances in products/kits", which have to be considered will be verified by the given methods taking into account the installation conditions of the construction product and the release scenarios resulting from there. Regulations related to placing the product on the market may also need to be taken into account.

The content of cadmium contained in zinc coatings shall be declared by the applicant.

Note (to be implemented in the ETA):

For dangerous substances falling under the scope of the CPD for which:

- no assessment and verification methods are given (or cannot be found in TR 034) or
- "no performance determined" is declared or
- the chosen verification and assessment method does not comply with the regulatory requirement of a particular Member State

there might be the necessity for an additional assessment.

2.7 Verification methods relating to Durability

2.7.1 Method of verification

2.7.1.1 Tests for checking durability of the metal parts (corrosion)

No special tests are required.

The durability of the coating of the metal part that ensures the suitability and the bearing behaviour of the anchor shall be shown. Furthermore it shall be shown that the coating does not negatively affect the durability of the bonding material. No special test conditions can be given in this Guideline for checking the durability of any coating because this depends on the type of coating. Any appropriate tests shall be decided on by the responsible Approval Body. Zinc coatings (electroplated or hot dip galvanised) need not be subjected to testing if used under dry internal conditions

2.7.1.2 Tests for checking durability of the bonding material

The durability of the bonding material (except for cementitious mortar) shall be verified by slice tests. With slice tests, the sensitivity of installed anchors to different environmental exposures can be shown. The slice tests shall be carried out in concrete. The slice test is described in Annex A, A.5.10 in detail.

Slice tests in an alkaline liquid are required only for applications in use category w/w according to section 2.3.2.2 if the injection anchor is installed in:

- masonry from normal weight or lightweight concrete masonry units
- joints of masonry made from clay or calcium silicate units filled with non carbonated cementitious mortar

Slice tests may be omitted for applications in:

- masonry made from normal weight or lightweight concrete masonry units if the characteristic resistance is calculated according to Equation (2.4.12) with $\alpha_3 = 0,3$
- joints of masonry units made out of clay or calcium silicate filled with cementitious mortar, if the characteristic resistance of the anchor for the corresponding masonry unit given in the ETA is $N_{Rk} \leq N_{Rk}$ (concrete brick) with N_{Rk} (concrete brick) calculated according to Equation (2.4.12) with $\alpha_3 = 0,5$ or the mortar is carbonated over the embedment depth of the anchor. Carbonated mortar may be assumed if the structure is sufficiently old (e.g. ≥ 15 years)

2.7.2 Method of assessing and judging

2.7.2.1 Durability of the metal parts

The assessment/testing required with respect to corrosion resistance will depend on the specification of the injection anchor in relation to its use. Supporting evidence that corrosion will not occur is not required if the steel parts of the metal injection anchor are protected against corrosion, as set out below:

Injection anchors intended for use in structures subject to dry, internal conditions:

No special corrosion protection is necessary for steel parts as coatings provided for preventing corrosion during storage prior to use and for ensuring proper functioning (e.g. a zinc coating with a minimum thickness of 5 microns) is considered sufficient.

Injection anchors for use in structures subject to external atmospheric exposure or exposure in permanently damp internal conditions:

The metal parts of the anchors shall be made of an appropriate grade of stainless steel. The grade of stainless steel suitable for the various service environments (marine, industrial, etc.) shall be in accordance with existing rules. Grade A4 of ISO 3506-1 and 2:2009 [4] or equivalent may be used under internal and external or other environmental conditions if no particularly aggressive conditions exist.

Injection anchors for use in structures subject to external atmospheric exposure or exposure in permanently damp internal conditions or particularly aggressive conditions:

If the anchor is to be used in particularly aggressive conditions such as permanent or alternate immersion in seawater or the splash zone of seawater, chloride atmosphere of indoor swimming pools or atmosphere with extreme chemical pollution (e.g. in desulphurization plants or road tunnels, where de-icing materials are used) stainless steel material 1.4529, 1.4565 and 1.4547 according to EN 10088-5 [5] can be used.

Where a form of protection (material or coating) other than those mentioned above is specified, it will be necessary to provide evidence in support of its effectiveness in the defined service conditions; with due regard to the aggressiveness of the conditions concerned.

If an anchor involves the use of different metals, these shall be electrolytically compatible with each other. In dry internal conditions, carbon steel is compatible with malleable cast iron.

Assessment of the durability of the coating is based on the type of coating and the intended conditions of use (i.e. dry internal or external conditions).

Note: Bolts or screws made of galvanised steel with high steel strength (>1 000 N/mm²; property class >10.9) may be sensitive to brittle fracture. Therefore the risk of brittle fracture has to be considered in the assessment of such products. Commercial standard rods made of galvanised steel should be used with property class 8.8 at most.

2.7.2.2 Durability of the bonding material

In the slice tests according to Annex A, A.5.10 it shall be shown that:

- the bond strength of the slices stored in an alkaline liquid is at least as high as that of the bond strength of the comparison tests on slices stored under normal conditions and
- the bond strength of the slices stored in sulphurous atmosphere media is not smaller than 0,9 times of the bond strength of the comparison tests on slices stored under normal conditions.

To show compliance with this requirement of the slice tests the factor α_3 shall be calculated according to Equation (2.7.1).

$$\alpha_3 = \frac{\tau_{um(stored)}}{\tau_{um,dry}} \quad (2.7.1)$$

with:

$\tau_{um(stored)}$ = mean bond strength of the slices stored in the corresponding atmosphere (alkaline fluid or in sulphurous),
 $\tau_{um,dry}$ = mean bond strength of the comparison tests on slices stored under normal condition

The bond strength in the slice tests shall be calculated according to Equation (2.7.2)

$$\tau_u = \frac{N_u}{\pi \cdot d \cdot h_{sl}} \quad (2.7.2)$$

with:

N_u = measured maximum load
 d = diameter of the embedded part
 h_{sl} = thickness of slice, measured values

If the value α_3 is less than 1,0 for the tests in alkaline fluid and 0.9 for tests in sulphurous atmosphere then the characteristic resistance N_{Rk} shall be reduced according to 2.4.2.2.3.

3 EVALUATION AND ATTESTATION OF CONFORMITY AND CE MARKING

3.1 System of attestation of conformity

According to the communication of the European Commission, the system of attestation of conformity laid down in Commission Decision 97/177/EC dated 17 February 1997 of the OJ L 073 dated 14 March 1997, is given in Table 3.1.

Table 3.1 – System of attestation of conformity applicable to "Metal injection anchors for use in masonry"

Product	Intended use	Level(s) or class(es)	Attestation of conformity system
Metal injection anchors for use in masonry	For fixing and/or supporting to masonry, structural elements (which contributes to the stability of the works) or heavy units		1

The system of attestation of conformity referred to above is defined as follows:

System 1: Certification of the conformity of the product by a notified certification body on the basis of:

- (a) Tasks for the manufacturer:
 - (1) factory production control;
 - (2) further testing of samples taken at the factory by the manufacturer in accordance with a prescribed test plan;
- (b) Tasks for the notified body:
 - (3) initial type-testing of the product;
 - (4) initial inspection of factory and of factory production control;
 - (5) continuous surveillance, assessment and approval of factory production control.

3.2 Tasks and responsibilities of the manufacturer and notified body

3.2.1 Tasks of the manufacturer

The cornerstones of the actions to be undertaken by the manufacturer of "Metal injection anchors for use in masonry" in the procedure of attestation of conformity are laid down in Table 3.2.

Table 3.2 is an example only; the control plan depends on the individual manufacturing process and has to be established between notified body and manufacturer for each product.

Table 3.2 – Control plan for the manufacturer; cornerstones

No	Subject/type of control	Test or control method	Criteria, if any	Minimum number of samples	Minimum frequency of control
(1)	(2)	(3)	(4)	(5)	(6)
Factory production control (FPC) [including testing of samples in accordance with a prescribed test plan]					
1	Metal part / dimensions and tolerances	Measuring or optical	Laid down in control plan	3	Every shift or 8 hours of production per machine
2	Metal part / material properties e.g. tensile strength or hardness, elastic limit, elongation on rupture	e.g. tensile test, hardness testing Brinell or Vickers	Laid down in control plan	3	Every shift or 8 hours of production per machine
3	Metal part / coating	Measuring of thickness	Laid down in control plan	3	Every shift or 8 hours of production per machine
4	Mortar / components / mass	Mass	Laid down in control plan	3	Every shift or 8 hours of production per machine
5	Mortar / condition		Laid down in control plan	2	Every shift or 8 hours of production per machine
6	Mortar / density		Laid down in control plan	2	Every shift or 8 hours of production per machine
7	Mortar / viscosity		Laid down in control plan	2	Every shift or 8 hours of production per machine
8	Fingerprint of bonding material				Each batch

3.2.2 Tasks for the notified body

The cornerstones of the actions to be undertaken by the notified body in the procedure of attestation of conformity for "Metal injection anchors for use in masonry" are laid down in Table 3.3.

Table 3.3 – Control plan for the notified body; cornerstones

No	Subject/type of control	Test or control method	Criteria, if any	Minimum number of samples	Minimum frequency of control
(1)	(2)	(3)	(4)	(5)	(6)
Initial type-testing of the product (ITT)					
1	Initial type testing will be available as part of the required assessment for issuing European Technical Approvals unless there are changes in the production line or plant. In such cases the ITT has to be agreed between the Approval Body and the notified body.	-	-	-	-
Initial inspection of factory and factory production control (FPC)					
2	Ascertain that the factory production control with the staff and equipment are suitable to ensure a continuous and orderly manufacturing of the injection anchor.	-	Laid down in control plan	-	1
Continuous surveillance, judgment and assessment of factory production control (FPC)					
3	Verifying that the system of factory production control and the specified automated manufacturing process are maintained taking account of the control plan.	-	Laid down in control plan	-	1/year

3.3 CE marking and accompanying information

According to Council Directive 93/68/EEC the CE marking consists of the letters "CE" in the form laid down in the Directive, followed by the identification number of the notified certification body.

The packaging or the delivery tickets associated with the product shall contain the CE marking and the following accompanied information:

- the name and address of the producer (legal entity responsible for the manufacture),
- the last two digits of the year in which the CE marking was affixed,
- the number of the EC certificate of conformity for the product,
- the number of the European Technical Approval,
- the number of the ETAG,
- size of the anchor,
- use category.

Example of CE marking and accompanying information:

 1234	Letters "CE" Identification number of notified certification body
Any Company Street 1, City, Country 10 1234-CPD-0321	Name and address of the producer (legal entity responsible for the manufacture) Two last digits of year of affixing CE marking Number of EC certificate of conformity
ETA-06/2135 ETAG 029 M10 / Use category b,c and w/w	Number of European Technical Approval ETAG number Size / use category

3.4 Marking of the product

Every injection anchor shall be clearly identifiable before installation¹⁾ and shall be marked by:

- the name or identifying mark of the producer
- the injection anchors identity (commercial name)
- the intended use (durability use, e.g. an additional mark for stainless steel anchors to distinguish them from non-stainless steel anchors). The intended use may be included in the injection anchor identity.
- the minimum anchorage depth or the maximum admissible thickness of the fixture
- if an injection anchor is designed for use at more than one anchorage depth while maintaining the same thread diameter, the anchorage depths available and used shall be discernible after installation of the injection anchor.

¹⁾ For use of commercial standard rods see 4.3

4 ASSUMPTIONS UNDER WHICH THE FITNESS FOR THE INTENDED USE IS ASSESSED

4.1 Design method for anchorages

The assessment of the injection anchor shall be made assuming that one of the design methods given in Annex C is used. However, if an alternative design method shall be proposed, the Approval Body shall judge this design method and the relevance of the assessment, in particular the relevance of the tests to be undertaken.

The overall assumption shall be made that the design and dimensioning of anchorages is based on technical considerations and in particular the following:

- Preparation of verifiable calculation notes and drawings for determining the relevant masonry in the region of the anchorage, the loads to be transmitted and their transmission to the supports of the structure.
- Consideration not only of direct loads but also the important additional loads caused by restraint of intrinsic (e.g. shrinkage) or extrinsic deformation (e.g. by temperature variations) in the injection anchor, in the fixture or in the base material together with verification of the distribution of loads in these structures and assemblies.
- It is to be ensured that the use category applies and the strength class, density etc. of the base material is not lower than that to which the characteristic loads apply.

4.2 Packaging, transport, storage of the product

Any special transport conditions shall be stated on accompanying documents.

Any special storage conditions shall be stated on packaging including:

Storage temperature range,
Restrictions such as keeping away from heat and direct sunlight,
Expiry date.

4.3 Installation of the product in the works

The loading capacity and reliability of anchorages are greatly affected by the manner in which the injection anchors are installed. The manufacturer's installation instructions therefore form a fundamental part of the assessment of the fitness for use of an injection anchor.

This Guideline takes account of a reasonable degree of imperfection in relation to installation and thus control methods on site after installation will in general not be necessary. This assumes, however, that gross errors on site will be avoided by use of instructions and correct training of the installers and supervision on site.

The anchor shall be used only as supplied by the manufacturer without exchanging the components of an anchor. Commercial standard threaded rods, washers and hexagon nuts may also be used if the following requirements are fulfilled:

1. Material, dimensions and mechanical properties of the metal parts (rod, washer, nut) according to the specifications given in the ETA
*Remark: The ETA has to contain all details of the metal parts.
The material of stainless steel is given according to EN 10088:2009 [5], the mechanical properties according to EN ISO 898-1 and 2:2009 [8] (galvanised steel) and according to EN ISO 3506-1 and 2:2009 [4] (stainless steel).*
2. Confirmation of material and mechanical properties of the metal parts by inspection certificate 3.1 according to EN 10204:2004 [9]; the documents shall be stored.
3. Marking of the rod with the envisaged embedment depth. This may be done by the manufacturer of the rod or the person on the job site.

Installation instructions shall typically include the following:

- Before placing an injection anchor, the checks to be made to ensure that the use category applies.
- Plaster or similar materials shall be removed, unless there is information from the planning engineer that this layer was taken into account.
- Holes to be drilled perpendicular (maximum deviation 5°) to the surface unless specifically required otherwise by the manufacturer's instructions.
- Normally hard metal hammer-drill bits in accordance with ISO or National Standards shall be used.
- All special drill bits (e.g. stopdrills or diamond core drill bits) required in accordance with manufacturer's installation instructions to be in compliance with the manufacturer's specifications. This may be checked by comparing the drill bit manufacturer's declared performance and characteristics against the specifications of the anchor manufacturer.
- Instructions for hole cleaning shall specify in detail the type of cleaning equipment to be used, e.g. the volume of blow out pump and diameter and material of brush, together with the precise cleaning procedure including the number and order of blowing/brushing actions.
- Injection anchors to be installed ensuring not less than the specified embedment depth. The edge distance and spacing to be kept to the specified values, no minus tolerances to be allowed.
- Remark to the different installation temperature

Temperature limits

The following temperature limits shall be specified:

Installation ambient temperature range

Bonding material installation temperature range.

Operational time limits

Open time and curing time shall be stated in relation to the relevant temperature limits, e.g.:

Open time related to bonding material installation temperature

Curing time in relation to installation ambient temperature

If tables are used to indicate times-versus-temperature ranges, they shall be inclusive so that the relevant time is clear for all temperatures within the appropriate range. An accepted example is given in the following:

	Installation ambient temperature °C	Curing time (minutes)
E.g.	5 to 15	120 min
	>15 to 25	60 min

The following example is not accepted:

Installation ambient temperature °C	Curing time (minutes)
5	120 min
15	60 min

When curing times are stated it shall be made clear that this is the earliest time that the injection anchor may be torqued or loaded. A longer waiting time may be recommended for proof of ultimate load tests on site; if so, this shall be stated.

Finally it is assumed that the necessary information and appropriate specifications for correct installation are available on site and that the person responsible transmits all the necessary information to the installer. It is to be further assumed that installation is carried out by trained personnel under the supervision of the person responsible for technical matters on site. Where pictograms are used, their meaning shall be clear and unambiguous. If necessary, text in the appropriate language shall be added to clarify the meaning.

5 IDENTIFICATION OF THE CONSTRUCTION PRODUCT

In order to ensure that the injection anchor samples used for the initial assessment conform to the specification referred to in the approval, it is necessary to identify their relevant specifications and characteristics which can influence their functioning, performance or durability.

Identification tests are for verifying the characteristics of the injection anchors, including dimensions, constituent materials, anti-corrosion protection and the marking of the injection anchors and various components.

Wherever possible, checks shall be carried out on finished components. Where dimensions or other factors prevent testing to a recognized standard, e.g. tensile properties where the required ratio of length to diameter does not exist in the finished component, then the tests shall still be carried out on the finished component if practicable, in order to produce results for comparison purposes. Where this is not possible, tests shall be carried out on the raw material; however, it shall be noted that where the production process changes the characteristics of the material, then a change to the production process can render the results of these tests invalid.

A minimum number of each component depending on factors such as the production process and the bag size is to be taken and dimensions measured and checked against the drawings provided by the manufacturer. The tolerances specified for all components shall be complied with and the dimensions of these elements shall conform to the appropriate ISO or European Standards where relevant.

The results obtained shall be assessed to ensure that they are within the manufacturer's specification.

The product which is the subject of the European Technical Approval shall be identified by:

- Testing of product characteristics as laid down in the following.
- Fingerprinting.
- Formulation.
- Manufacturing process parameters.
- Calculations, detailing, drawings.

Metal parts:

During tests on the constituent materials of the components of the metal parts, the following properties shall be determined: tensile strength, elastic limit, elongation at rupture, hardness. The measured values shall be compared with minimum values or strength classes indicated in ISO or European Standards. The manner in which the components are fabricated shall also be checked (e.g. cold-forming, quenching, hardening). For the testing of carbon steel screws, bolts, nuts, reference can be made to ISO 898-1 and 2. For the testing of stainless steel screws, bolts, nuts reference can be made to ISO 3506-1 and -2. For quenched components, the surface hardness and case depth are to be determined. Hardness testing shall be by either the Brinell or Vickers methods. Wherever possible, the material declaration, according to the relevant material standard, shall be provided.

Bonding material:

All components of the bonding materials shall be described in a chemically unambiguous way and be identified by standard tests (e.g. fingerprinting tests). All component amounts shall be specified either by mass, volume or percentage, with appropriate tolerances.

The following characteristics shall be specified where relevant in accordance with ISO, European or national standards, together with any others as appropriate.

1 Organic Bonding agents

Resin, hardener and additives shall be identified by the following tests:

- density
- viscosity
- ignition loss and ash content
- conventional dry extract
- grain size analysis
- tensile strength
- bending strength
- compressive strength
- open time
- reactivity (gel or setting time) (this may be tested with a standardised formulation, not necessarily that specified for the bonding anchor)

In addition, the following tests are necessary:

Resin and hardener cured by polyaddition mechanism

Epoxies

- epoxy index (equivalent)
- amine equivalent

Polyurethanes

- hydroxyl equivalent
- isocyanate equivalent

Resin and hardener cured by polymerisation

Unsaturated polyester, vinylester (epoxymethacrylates) and vinylesterurethanes (urethanmethacrylates)

- hardener (catalyst) content of peroxide

Methylmethacrylates (MMA)

- hardener, content of peroxide

Filler

- specification of filler material (e.g. tested by density) including type
- specification of filler shape (e.g. fibre, balls, ...)
- grain size analysis

2 Inorganic bonding agents

- material specification by chemical analysis
- active binder batching
- grain size analysis
- density
- dry extract
- setting test
- shrinkage and swelling test
- bend and compressive strength at 7 and 28 days
- ignition loss and ash content

Filler, additives

- specification of filler material and additives
- specification of filler shape

6 FORMAT OF ETAS ISSUED ON THE BASIS OF THE ETAG

6.1 Definition of the anchor and its intended use

- Definition
- Intended use
 - Use categories in respect of the base material
 - Use categories in respect of installation and use
 - Use categories in respect of to the service temperature range
- Assumed working life

6.2 Characteristics of the anchor with regard to safety in use and methods of verification

- Definition of the base material which was used in the tests (type of material, strength, density, hole dimensions, dimensions of the brick)
- Minimum allowable edge distance and minimum allowable spacing
- Characteristic edge distance and characteristic spacing
- In addition to the specific clauses relating to dangerous substances contained in the European Technical Approval, there may be other requirements applicable to the products falling within its scope (e.g. transposed European legislation and national laws, regulations and administrative provisions). In order to meet the provisions of the EU Construction Products Directive, these requirements need also to be complied with, when and where they apply.

Note: For dangerous substances falling under the scope of the CPD for which:

- no assessment and verification methods are given (or cannot be found in TR 034) or
- "no performance determined" is declared or
- the chosen verification and assessment method does not comply with the regulatory requirement of a particular Member State

there might be the necessity for an additional assessment.

6.3 Evaluation and attestation of conformity and CE marking

- System of attestation of conformity
- Responsibilities
- CE-marking

6.4 Assumptions under which the fitness of the product for the intended use was favourably assessed

- Manufacturing
The ETA is issued for the product on the basis of agreed data/information, deposited with the Approval Body which identifies the product that has been assessed and judged. Changes to the product/production process, which could result in this deposited data/information being incorrect, shall be notified to the Approval Body before the changes are introduced. The Approval Body will decide whether or not such changes affect the ETA and consequently the validity of the CE marking on the basis of the ETA and if so whether further assessment/alterations to the ETA, shall be necessary.
- Design of anchorages
The anchorages are designed in accordance with the ETAG 029, Annex C.
- Installation

7 REFERENCE DOCUMENTS

- [1] Directive relating to construction products (CPD): Council Directive of 21 December 1988 on the approximation of laws, regulations and administrative provisions of the Member States relating to construction products (89/106/EEC) taking account of the modified provisions (93/68/EEC)
- [2] EN 771-1 to 5:2011: Specification for masonry units
- [3] EN 12602:2008: Prefabricated reinforced components of autoclaved aerated concrete
- [4] ISO 3506-1 and 2:2009: Mechanical properties of corrosion-resistant stainless-steel fasteners – Part 1: Bolts, screws and studs; Part 2: Nuts
- [5] EN 10088-4 and 5:2009: Stainless steels – Part 4: Technical delivery conditions for sheet/plate and strip of corrosion resisting steels for construction purposes; Part 5: Technical delivery conditions for bars, rods, wire, sections and bright products of corrosion resisting steels for construction purposes
- [6] EN 1996-1-1:2005 + AC:2009: Design of masonry structures. Part 1-1: General rules for reinforced and unreinforced masonry structure
- [7] EOTA: TR 020: Evaluation of Anchorages in Concrete concerning Resistance to Fire
- [8] ISO 898-1 and 2:2009: Mechanical properties of fasteners made of carbon steel and alloy steel - Part 1: Bolts, screws and studs with specified properly classes – coarse thread and fine pitch thread; Part 2: Nuts with specified properly classes – coarse thread and fine pitch thread
- [9] EN 10204:2004: Metallic products – Types of inspection documents
- [10] ISO 5468:2006: Rotary and rotary impact masonry drill bits hard metal tips – Dimensions
- [11] EN 1990:2002 + A1:2005 / AC:2010: Eurocode 0: Basis of Structural Design
- [12] EN 1991-1-1:2002 + AC:2009: Eurocode 1: Actions on Structures – Part 1-1: General actions – Densities, self-weight, imposed loads for building
- [13] EN ISO 6988:1994: Metallic and other non-organic coatings – sulphur dioxide test with general condensation of moisture
- [14] EOTA: ETAG 001, Annex A: Edition 1997, Amendment November 2006: Guideline for European technical approval of metal anchors for use in concrete, Annex A: Details of test

- [15] EN 1998-1:2004 + AC:2009: Eurocode 8: Design of structures for earthquake resistance – Part 1: General rules, seismic actions and rules for buildings
- [16] EN 772-1:2011: Methods of test for masonry units – Part 1: Determination of compressive strength
- [17] EOTA: ETAG 001, Part 5: Edition 2002, Amendment November 2012: Guideline for European technical approval of metal anchors for use in concrete, Part 5: Bonded Anchors
- [18] EOTA TR 034 "General Checklist for ETAGs/CUAPs/ETAs - Content and/or release of dangerous substances in products/kits"